



Tronical
COMPONENTS

TRONICALTUNE

WE ARE SPINNING HEADS!

MANUAL

V 2.12

TRONICAL TUNE - INDEX

»»»	TRONICAL TUNE OVERVIEW	3
»»»	TRONICAL TUNE - INSERT/REPLACE BATTERY	4-5
»»»	TUNE CONTROLLER	6
»»»	GETTING STARTED	
	INSTALL THE SYSTEM TO THE GUITAR	7-8
	STRING YOUR GUITAR	9-12
	STRING UP AND DOWN MODE	13
	HOW TO TUNE / ADDITIONAL INFO	14
	PERFORMANCE SPECIFICATION	15
»»»	START TO TUNE	
	MULTI-STRING / SINGLE-STRING TUNING	16-17
	SWITCH BETWEEN BANKS	18
	EXAMPLE	19
	BANK OVERVIEW	20
»»»	FUNCTION MENU	
	FUNCTION OVERVIEW	21
	CUSTOM TUNING SAVING	22-23
	REFERENCE TUNING	24
	FIRMWARE VERSION	25
	BATTERY LEVEL	26
»»»	CONFIGURATION MENU	
	OVERVIEW	27
	ACCURACY MODE	28
	ROBOHEAD DELAY	29
	RESET MODE	30
	ROBOHEAD SPEED	31
	INTERFERENCE LEVEL	32
»»»	SYSTEM CONFIGURATION (EXPERT MENU)	33-37
»»»	CHARGING THE BATTERY	38
»»»	LEGAL INFORMATION	39

TRONICAL TUNE - OVERVIEW

6 ROBOHEADS

WITH NEW SURFACE LOCKING MECHANISM

INTEGRATED LED-DISPLAY

(6 STRING LEDS, 1 MENU LED, 1 CHARGE LEVEL LED)

BATTERY

EXCHANGEABLE, RECHARGEABLE
3.7 VOLTS, LI-POLYMER, APPROX. 300 TUNINGS



BLACK TUNING CONTROLLER

BLACK MOUNTING BOARD WITH ROBOHEAD GUIDANCE



TUNE CONTROLLER

(UP, DOWN, LEFT, RIGHT, ENTER)

ON/OFF/BACK

AVAILABLE SPARE PARTS

- »»» Li-Po BATTERY
- »»» CHARGER WITH WALL-PLUG
- »»» ROBOHEADS
- »»» TUNING CONTROLLER WITH MOUNTING BOARD
- »»» WRENCH, LOCK NUTS & RING WASHERS

TRONICAL TUNE >>> REPLACE BATTERY

! **ATTENTION:** USE CAUTION WHEN INSTALLING THE BATTERY. ENSURE YOU PAY ATTENTION TO THE SLOTTED DESIGN TO GUARANTEE PROPER ORIENTATION. SLIDE IN THE BATTERY WITH THE TIP SIDE ONLY. DO NOT APPLY ANY FORCE AS YOU MAY CAUSE DAMAGE TO THE ELECTRONICS.

1 PRESS ON THE BATTERY TO RELEASE.

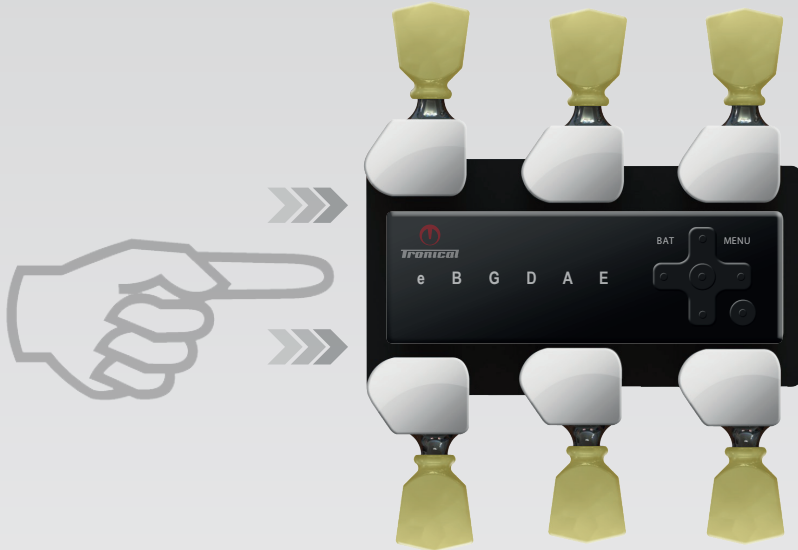

2 PULL OUT THE BATTERY

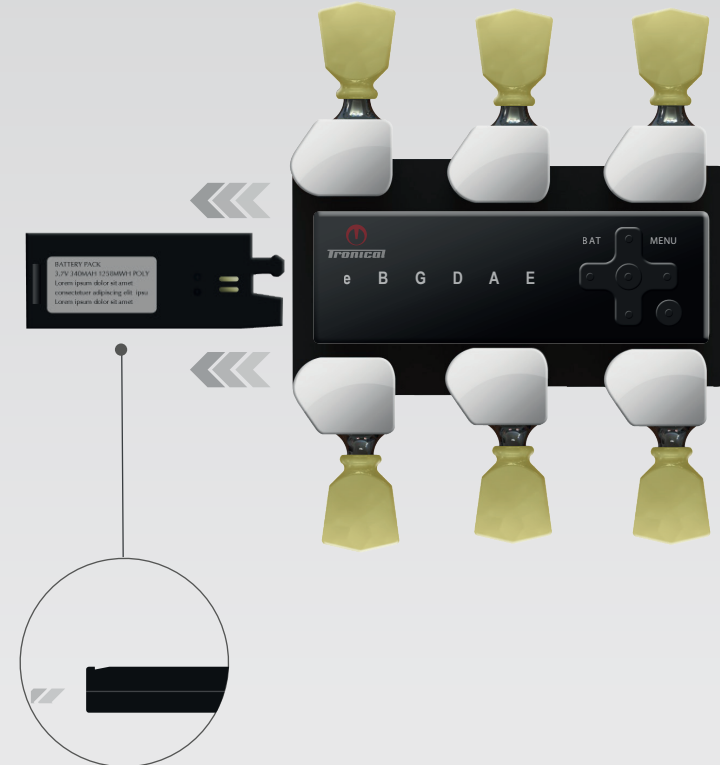







EXPLANATION - TUNE CONTROLLER





i PUSH AND HOLD THE "OFF-BUTTON" TO SWITCH OFF THE SYSTEM.

LED EXPLANATION DURING THE TUNING (e-E)





-  : STRING IN TUNE
-  : STRING NOT IN TUNE (PICK STRING)
-  : FREQUENCY OUT OF PITCH WINDOW
-  : RESPECTIVE ROBOHEAD IS IN MOVEMENT
-  : FREQUENCY MEASUREMENT IN PROGRESS
-  : INTERFERENCE BETWEEN LOWER AND HIGHER STRINGS

i MUTE LOWER STRINGS THAT ARE IN TUNE AND STRUM HIGHER STRINGS AGAIN.



LED EXPLANATION (BAT)

-  : BATTERY FULLY CHARGED
-  : BATTERY IS LOW
-  : BATTERY IS EMPTY

LED EXPLANATION (MENU)

-  : TUNING IS ACTIVE
-  : CONFIGURATION MENU
-  : FUNCTION MENU
-  : SYSTEM CONFIGURATION

BLINKING MENU LED

-  : ACOUSTIC GUITAR
-  : ELECTRIC GUITAR

GETTING STARTED INSTALL THE SYSTEM TO THE GUITAR



NOTE: DO NOT USE ANY TOOLS TO FIX THE LOCK NUT AND DO NOT OVER TIGHTEN AS YOU MAY. USE A **1 CENT COIN** TO TIGHTEN THE LOCKNUT, OTHERWISE YOU MAY DAMAGE THE GEAR WHEELS!!



USE ONLY SUPPLIED WRENCH OR TORQUE WRENCH TO TIGHTEN THE HEX NUTS (**MAX. 1.5 NM TORQUE**)

IT IS RECOMMENDED TO USE A CONTACT CLEANING SOLUTION BEFORE INSTALLING THE ROBOHEADS TO THE PCB BOARD AND TO ALSO NOT OVER TIGHTEN THE HEX NUTS BEFORE ENSURING ALL CONTACTS ARE MAKING A GOOD CONNECTION.

USE CAUTION WHEN INSTALLING BATTERY AND ENSURE YOU PAY ATTENTION TO THE SLOTTED DESIGN TO GUARANTEE PROPER ORIENTATION!!!

GETTING STARTED INSTALL THE SYSTEM TO THE GUITAR

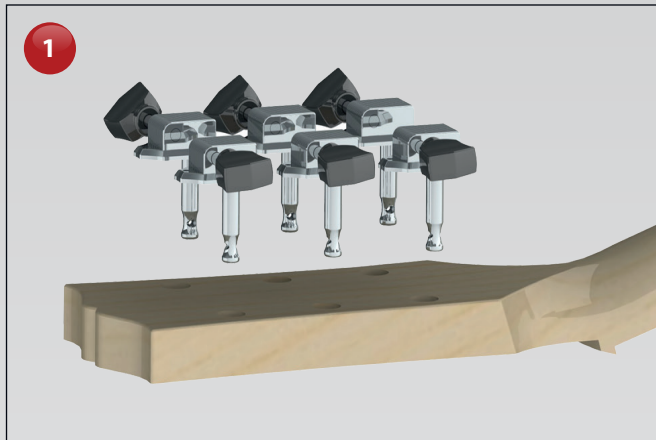

1
AT FIRST REMOVE ALL ORIGINAL HEADSTOCK-PARTS OF YOUR GUITAR.



2
TAKE THE ROBOHEADS OUT OFF THE CONTACTING PCB.



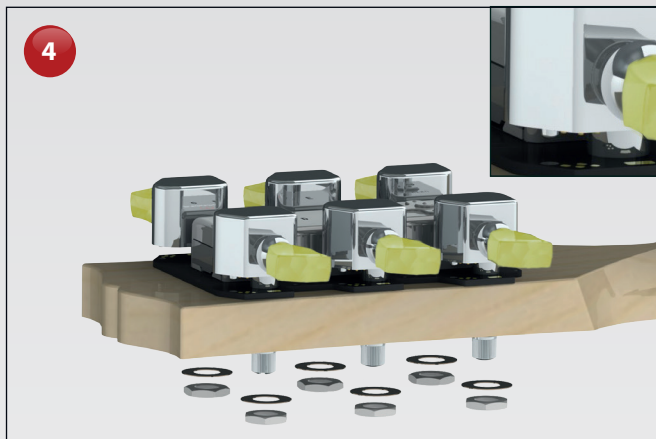

3
PLACE THE CONTACTING PCB ON THE NECK OF THE GUITAR, THE BATTERY COMPARTMENT HAS TO FACE TOWARDS THE TOP OF THE HEADSTOCK.



4
MAKE SURE THAT ALL PCB DRILL HOLES ARE IN ALIGNMENT WITH THE NECK'S TUNER HOLES. PUT THE ROBOHEADS THROUGH THE RESPECTIVE HOLES. MOUNT THE HEX-NUTS.



5
 
USE THE WRENCH WHICH COMES WITH THE SET TO SCREW TIGHT THE HEX NUTS OF THE ROBOHEADS.

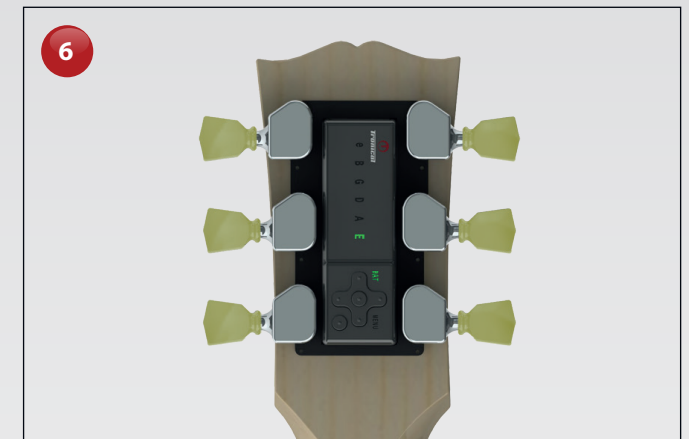

6
NOW TRONICAL TUNE IS READY TO STRING UP YOUR GUITAR.



GETTING STARTED STRING YOUR GUITAR

MAX. RECCOMENDED STRING GAUGES: .013 .017 .026 .035 .045 .056 (THIRTEEN TO FIFTY-SIXES)

NOTE: HIGHER STRING GAUGES MAY CAUSE DAMAGE TO THE TUNERS!

PLEASE NOTE THE BASS SIDE ROBOHEADS TURN IN THE OPPOSITE DIRECTION FROM USUAL. THEY NOW TURN CLOCKWISE TO SHARPEN AND COUNTERCLOCKWISE TO FLATTEN.



GETTING STARTED HOW TO USE THE STRING SHAFT WITH SURFACE LOCKING MECHANISM



NOTE: DO NOT USE ANY TOOLS TO FIX THE LOCK NUT AND DO NOT OVER TIGHTEN AS YOU MAY. USE A **1 CENT COIN** TO TIGHTEN THE LOCKNUT, OTHERWISE YOU MAY DAMAGE THE GEAR WHEELS!!



USE ONLY SUPPLIED WRENCH OR TORQUE WRENCH TO TIGHTEN THE HEX NUTS (**MAX. 1.5 NM TORQUE**)

- 1 LOCK NUT:** YOU NEED THE LOCK NUT TO TIGHTEN THE STRING.
- 2 STRING SHAFT:** THE STRING SHAFT WINDS THE STRING.
- 3 STRING RECESS:** THE STRING RECESS GUIDES THE STRING.
- 4 HEX NUT:** USE THE WRENCH WHICH COMES WITH THE SET TO TIGHTEN THE HEX NUTS OF THE ROBOHEADS.

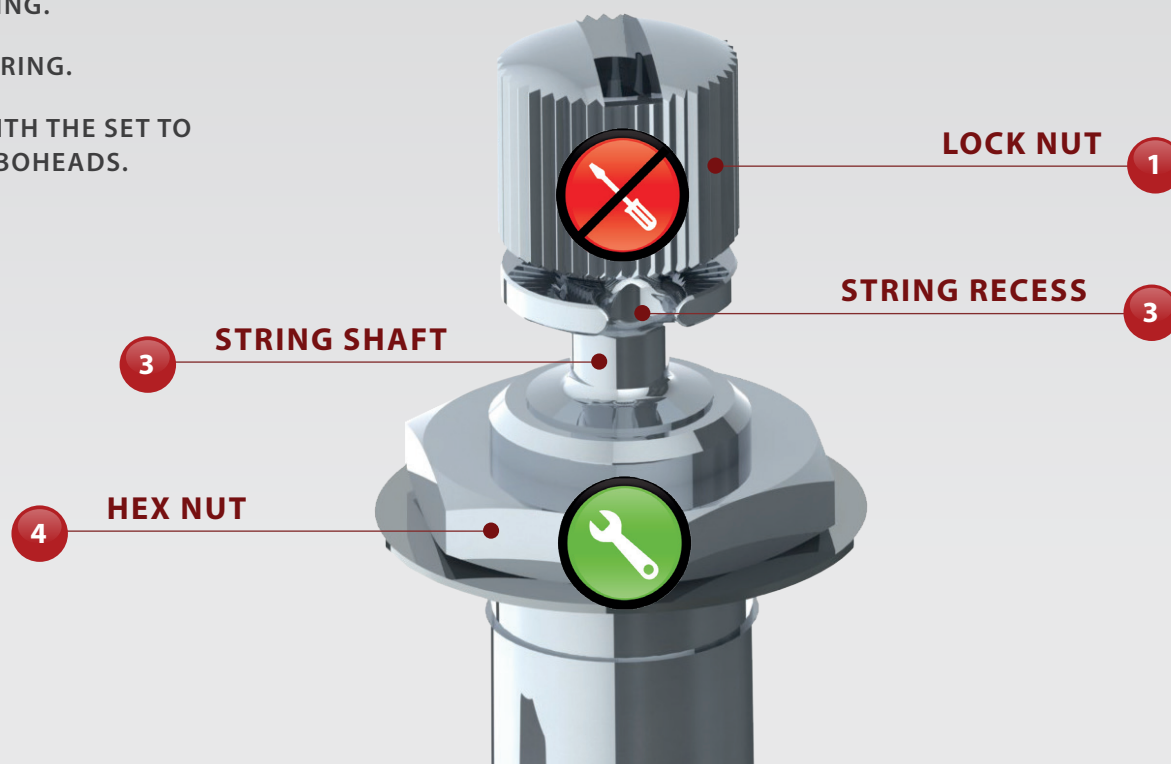

GETTING STARTED >>> HOW TO USE THE STRING SHAFT



1

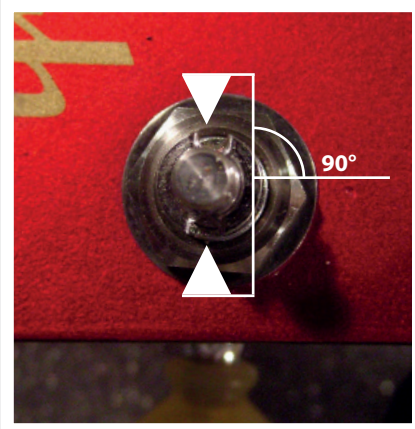

SCREW OFF THE LOCK NUT AND MAKE SURE THAT THE RECESS IS AT AROUND 90 DEGREES TO LONGITUDINAL DIRECTION OF THE NECK. YOU CAN TURN MANUALLY ON THE KEY OR BY STRING UP MODE (PAGE 11)

2

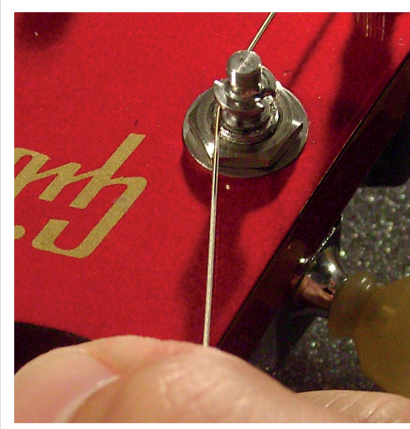

PULL TIGHT ON THE STRING TO GET PRETENSION AND BEND IT ONE HALF TURN AROUND THE BOTTOM SIDE OF THE STRING SHAFT.



3



MERGE THE STRING UP THROUGH THE STRING RECESS TOWARDS THE THREAD.

4

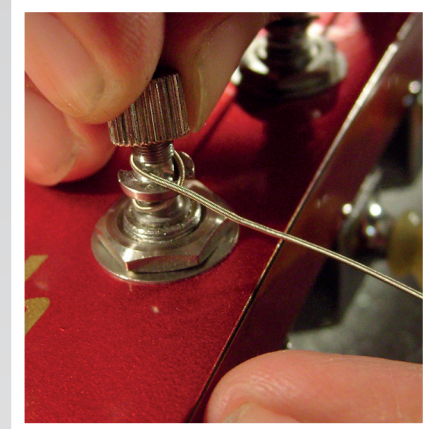

BEND THE STRING AROUND THE SHAFT AS SHOWN IN THE PICTURE AND A SCREW ON THE LOCK NUT.

NOTE

TO ENSURE BOTH HIGH „e“ & „B“ STRINGS ARE SECURELY LOCKED, WE RECOMMEND MAKING **TWO** WINDINGS AFTER RAISING THE STRING UP TO THE THREAD OF THE POST.

2x
WINDINGS



GETTING STARTED >>> HOW TO USE THE STRING SHAFT



5



TIGHTEN WITH A SMALL COIN THE LOCK NUT SMOOTHLY BY HAND. THE STRING MUST ENCIRCLE THE STRING SHAFT COMPLETELY.

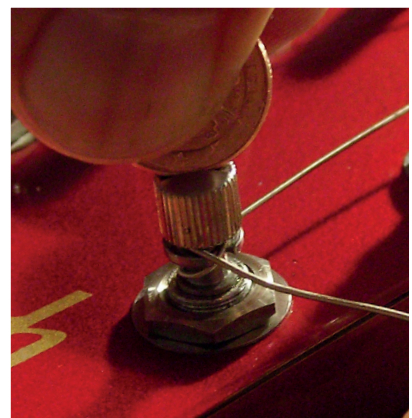

6



CUT THE END OF THE STRING CLOSE TO THE STRING SHAFT.

7



NOTE: DO NOT USE ANY TOOLS TO FIX THE LOCK NUT AND DO NOT OVER TIGHTEN. USE A **1 CENT COIN** TO TIGHTEN THE LOCKNUT, OTHERWISE YOU MAY DAMAGE THE GEAR WHEELS!!



FUNCTION MENU E **STRING UP AND DOWN MODE**

FOR RESTRINGING YOUR GUITAR



PUSH "ON" button. The system activates with the last completed tuning in **MULTI-STRING MODE**.

PUSH "BACK" button to enter TUNING SELECTION MODE. MENU LED is **OFF**.

TO ENTER FUNCTION MENU

PRESS AND HOLD THE "UP" button until MENU LED lights up WHITE.

SELECT WHITE "E" -LED. PUSH "ENTER" to confirm.
The **MENU LED** switches **OFF**, The "E" lights up **RED**.

PRESS "DOWN" to unwind the low "E" string or PRESS "UP" to wind up the low "E" string.

PRESS "LEFT" or "RIGHT" button to choose any other string to wind up or down in the same manner.

PRESS "BACK" for FUNCTION MENU.



DURING "STRING UP AND DOWN MODE" THE "SINGLE-STRING TUNING MODE" IS ACTIVE. IT IS RECOMMENDED TO WIND THE STRING ROUGHLY (+- 300 CENT) TO STANDARD PITCH, THEN RELEASE THE UP/DOWN BUTTON AND PLUCK THE STRING. THE SYSTEM TAKES OVER AND WILL TUNE THE STRING TO STANDARD PITCH AND AUTOMATICALLY MOVE TO THE NEXT STRING.



IMPORTANT!
REFER to Page 36 to SELECT GUITAR TYPE (ACOUSTIC or ELECTRIC INSTALLATION)

**SEE ADDITIONAL
FUNCTIONS
PG. 19**

GETTING STARTED HOW TO TUNE / ADDITIONAL INFORMATION

RE-TUNING

- 1** (STRUM BY THUMB, CLOSE TO THE NECK JOINT (SOUND HOLE), 1 STRUM = ALL STRINGS WITHIN 1 SEC.)
- 2** WAIT 3-5 SECONDS BETWEEN TWO STRUMS
- 3** AFTER STRUMMING, MUTE STRINGS THAT ARE ALREADY IN TUNE (GREEN LED ON TUNE CONTROLLER) AND STRUM THE OUT-OF-TUNE STRINGS ONLY.

CHANGE TUNING

- 1** To change the actual tuning (e.g. from Standard to DADGAD) you can select the **"SINGLE-STRING MODE"** or the **"MULTI-STRING MODE"** .

SINGLE STRING MODE is activated with a **PRESS AND HOLD "ENTER"**

MULTI- STRING MODE is activated with a **PUSH, "ON"** button (for details please refer to "Tune Mode [page 15](#) and following").

SINGLE STRING MODE is recommended to get familiar with the system and when you use the system in a loud environment with ambient noise (especially with acoustic guitars).

MULTI-STRING MODE is recommended as the default mode as soon you are used to the system.

- !** PLEASE NOTE THE BASS SIDE ROBOHEADS TURN IN THE OPPOSITE DIRECTION FROM USUAL. THEY NOW TURN CLOCKWISE TO SHARPEN AND COUNTERCLOCKWISE TO FLATTEN.

GETTING STARTED PERFORMANCE SPECIFICATION

1) BEST PERFORMANCE UNDER FOLLOWING CONDITIONS:

* FOLLOW THE MANUAL FROM PAGE 3 TO PAGE 14!!

* FOR THE BEST TUNING PERFORMANCE MAKE SURE THAT THE STRINGS ARE NOT STICKING IN THE NUT (STRING FRICTION).

* THE INTONATION OF 12TH FRET FINGERED TO 12TH FRET HARMONIC SHOULD BE CORRECT

* FOR STANDARD TUNING 440 HZ

* DETUNING WITHIN THE NOMINAL +/- 30 CENT RANGE.

* WITH A GOOD BATTERY CHARGE, EG. "BAT" INDICATOR IS GREEN

* ACCURACY SET TO STANDARD, 3 LEDS (+/- 2.5 CENT ACCURACY)

		MIN	NOM	MAX	UNIT
TUNING TIME	SINGLE-STRING MODE	3	5	10	sec per string
	MULTI-STRING MODE	3	10	20	sec all strings





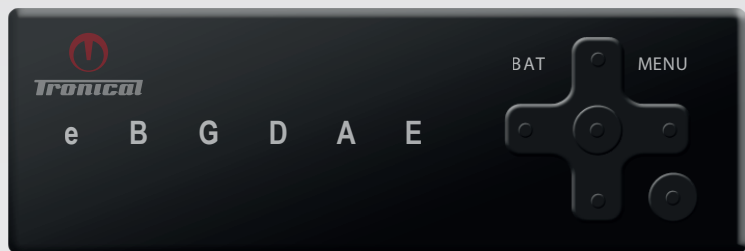

		MIN	NOM	MAX	UNIT
NUMBER OF STRUMS	SINGLE-STRING MODE	1	2	4	strums per string
	MULTI-STRING MODE	1	3	5	strums all strings

START TO TUNE >>> TUNE MODE - MULTI-STRING TUNING



- 1- PRESS "ON". The **MULTI-STRING MODE** activates with the last completed tuning.
- 2- Strum ALL strings at once (**within 1sec.**)
- 3- Wait 3-5 seconds and mute the strings with your hand.
- 4- Mute the strings that are already in tune (**GREEN**).
- 5- Pick only the out-of-tune strings (**RED**)

IT IS IMPORTANT TO STRUM THE SAME WAY ALWAYS AT THE SAME POSITION NEAR THE END OF THE NECK WITH EITHER YOUR THUMB, FINGER OR PICK.

-  : STRING IN TUNE
-  : STRING NOT IN TUNE (PICK STRING)
-  : FREQUENCY OUT OF PITCH WINDOW
-  : RESPECTIVE ROBOHEAD IS IN MOVEMENT
-  : FREQUENCY MEASUREMENT IN PROGRESS
-  : INTERFERENCE BETWEEN LOWER AND HIGHER STRINGS
-  MUTE LOWER STRINGS THAT ARE IN TUNE AND STRUM HIGHER STRINGS AGAIN.



PRESS & HOLD "ENTER" TO CHANGE TO SINGLE STRING MODE.

WHEN TUNING IS COMPLETED THE SYSTEM TURNS OFF AUTOMATICALLY.

START TO TUNE >>> TUNE MODE - SINGLE-STRING TUNING

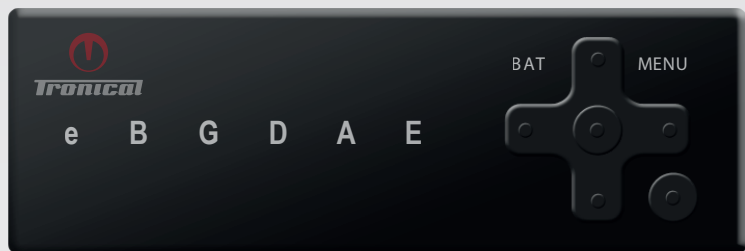

1- **PRESS & HOLD "ON"**. The **SINGLE STRING MODE** activates with the last completed tuning.



If you are in **TUNING SELECTION MODE** already, select desired **PRESET**, then **PRESS & HOLD "ENTER"** for single string tuning.

2- **PICK ONE STRING AT A TIME** as indicated, until all strings are in tune (**GREEN**).



PRESS "LEFT" OR "RIGHT" TO SELECT A STRING YOU WOULD LIKE TO TUNE.



MUTE STRINGS THAT ARE ALREADY IN TUNE (GREEN).



SEE LED EXPLANATION ON PAGE 4 OR SEE MULTI-STRING TUNING

WHEN TUNING IS COMPLETED THE SYSTEM TURNS OFF AUTOMATICALLY.

START TO TUNE >>> TUNING SELECTION

>>> SWITCH BETWEEN RED, GREEN AND BLUE BANKS



PRESS "ON". The **MULTI-STRING MODE** activates with the last completed tuning.

Now **PRESS "BACK"** on the tuner controller for **TUNING SELECTION**. The **MENU LED** will switch **OFF**.

PRESS "UP/DOWN" to navigate between the **RED** (Standard), **GREEN** (Major) and **BLUE** (User) Banks. Each bank holds 6 tunings.

PRESS "LEFT/RIGHT" to select any Tuning (E-e)

SINGLE-CLICK ON "ENTER" to activate selected tuning in **MULTI-STRING MODE** or **PRESS AND HOLD "ENTER"** for **SINGLE-STRING MODE**.

The **MENU LED** will light up **BLUE**.

START TO TUNE >>> TUNING SELECTION

>>> EXAMPLE: "OPEN G" MAJOR CHORD



PUSH "ON" button, the system will come up with the last complete tuning.
PUSH "BACK" to enter **TUNING SELECTION MODE**. The **MENU LED** switches **OFF**.

PUSH "UP" or **"DOWN"** to navigate to the **GREEN** (Major) Bank.



THE RESPECTIVE COLOR IS INDICATED BY THE COLOR OF THE STRING LED'S

PUSH "LEFT/RIGHT" until **G-LED** is shining **GREEN**.

SINGLE-CLICK "ENTER" for **MULTI-STRING MODE** or **PUSH & HOLD "ENTER"** for **SINGLE-STRING MODE**

Once the tuning is activated the RoboHeads start immediately in order to change the pitch. Keep your hands away from RoboHeads and strings during this automatic move phase (0.5 to 2 seconds).

AFTER ALL ROBOHEADS HAVE STOPPED:

MUTE ALL STRINGS & PICK THE INDICATED OUT OF TUNE STRING (RED) or **STRUM ALL OUT OF TUNE STRINGS (MULTI STRING MODE)** to start fine tune phase.

MUTING THE IN TUNE STRINGS (GREEN) while tuning is also recommended for improved accuracy. When all strings are in tune the system switches off automatically.

START TO TUNE >>> TUNING SELECTION

>>> BANK OVERVIEW

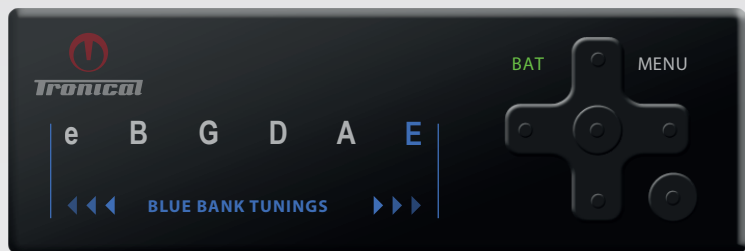
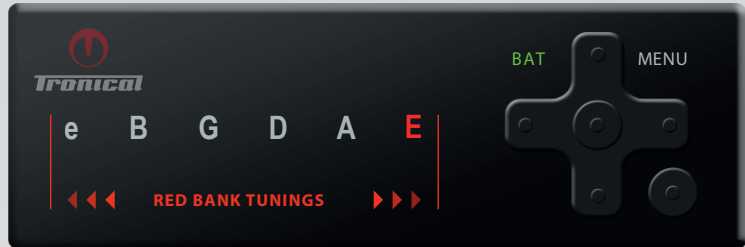

THE RED BANK

	E6 th	A5 th	D4 th	G3 rd	B2 nd	e1 st
E "STANDARD"	E2	A2	D3	G3	B3	E4
A "DADGAD"	D2	A2	D3	G3	A3	D4
D "WHOLE STEP"	D2	G2	C3	F3	A3	D4
G "DROP-D"	D2	A2	D3	G3	B3	E4
B "E-FLAT"	E _b 2	A _b 2	D _b 3	G _b 3	B _b 3	E _b 4
e "DOUBLE DROP-D"	D2	A2	D3	G3	B3	D4

THE GREEN BANK

	E6 th	A5 th	D4 th	G3 rd	B2 nd	e1 st
E "OPEN E"	E2	B2	E3	G#3	B3	E4
A "OPEN A"	E2	A2	E3	A3	C#4	E4
D "OPEN D"	D2	A2	D3	F#3	A3	D4
G "OPEN G"	D2	G2	D3	G3	B3	D4
B "DOBRO"	G2	B2	D3	G3	B3	D4
e "ALL 4TH"	E2	A2	D3	G3	C4	F4

THE BLUE BANK

	E6 th	A5 th	D4 th	G3 rd	B2 nd	e1 st
E "USER-DEFINED 01"	E2	A2	D3	G3	B3	E4
A "USER-DEFINED 02"	E2	A2	D3	G3	B3	E4
D "USER-DEFINED 03"	E2	A2	D3	G3	B3	E4
G "USER-DEFINED 04"	E2	A2	D3	G3	B3	E4
B "USER-DEFINED 05"	E2	A2	D3	G3	B3	E4
e "USER-DEFINED 06"	E2	A2	D3	G3	B3	E4



THE DEFAULT FOR ANY TUNING IN THE BLUE BANK IS STANDARD TUNING. TO SAVE USER-DEFINED TUNINGS, SEE "FUNCTION MENU - CUSTOM TUNING"

FUNCTION MENU FUNCTION OVERVIEW

 STRING UP AND DOWN MODE / CUSTOM TUNING /
REFERENCE TUNING / FIRMWARE VERSION / BATTERY LEVEL

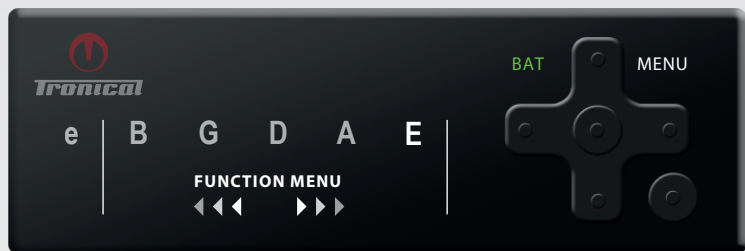

PUSH **"ON"** button. The system activates with the last completed tuning in **MULTI-STRING MODE**.

PUSH **"BACK"** button to enter **TUNING SELECTION MODE**. **MENU LED** is **OFF**.

TO ENTER FUNCTION MENU:

PRESS AND HOLD THE "UP" button until **MENU LED** lights up **WHITE**.

PRESS "LEFT/RIGHT" to navigate through the **FUNCTION MENU (E, A, D, G, B)**.

PRESS "ENTER" to confirm or **PRESS "BACK"** for **TUNING SELECTION MODE**.

FUNCTION MENU OVERVIEW

- E** → STRING UP AND DOWN MODE (PG. 11)
- A** → CUSTOM TUNING MODE (PG. 20-21)
- D** → REFERENCE TUNING (PG. 22)
- G** → FIRMWARE VERSION (PG 23)
- B** → BATTERY LEVEL (PG. 24)

FUNCTION MENU A CUSTOM TUNING



TUNE YOUR GUITAR MANUALLY TO ANY TUNING THAT YOU WISH TO SAVE ON A PRESET POSITION (BLUE BANK)

PUSH **"ON"** BUTTON the system comes up with the last completed tuning in **MULTI-STRING MODE**.

PUSH **"BACK"** button to enter **TUNING SELECTION MODE**. **MENU LED** is **OFF**.

TO ENTER **FUNCTION MENU**:

PRESS AND **HOLD THE "UP"** button until **MENU LED** lights up **WHITE**. PRESS **"LEFT/RIGHT"** button to **SELECT WHITE "A"-LED** and PRESS **"ENTER"**.

PICK THE STRING INDICATED BY THE **RED BLINKING LED** starting with low **"E"**. Measurement begins indicated by quick **YELLOW FLASHING "E"-LED**. Upon completion the **"E"-LED** will light up solid **GREEN**.

MUTE THE "E" STRING and **PROCEED WITH THE "A" STRING** in the same manner and so forth until all strings are measured (**GREEN**).

CONTINUED ON NEXT PAGE...

EXAMPLE:

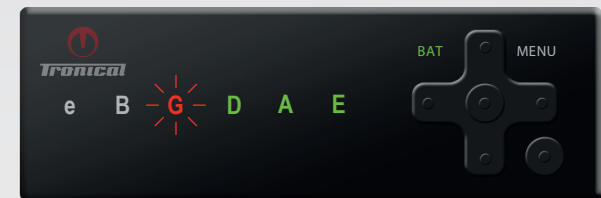
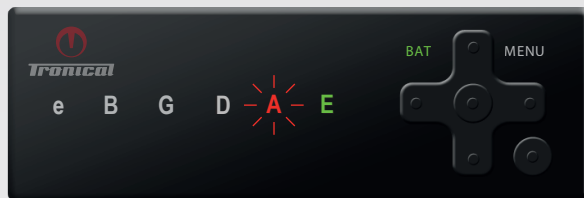

ETC.

FUNCTION MENU **A** CUSTOM TUNING | SAVING



Upon completion of measurement the system switches to the **BLUE** (User) bank automatically indicated by the **BLUE FLASHING LED**.

PUSH "LEFT/RIGHT" to select one of six preset positions (E-e)
PUSH "ENTER" to save your tuning.

ALL STRING LED'S WILL FLASH GREEN TWO TIMES FOR CONFIRMATION.

The system switches back to **FUNCTION MENU** automatically.
 The **MENU LED** lights up **WHITE**.

PUSH "BACK" for **TUNING SELECTION MENU** or
PUSH AND HOLD "BACK" to **SWITCH THE SYSTEM OFF**.

THE ACTUAL FREQUENCY RANGE LIMITS ARE AS FOLLOWS:

E	60	-	102 HERTZ
A	80	-	135 HERTZ
D	115	-	180 HERTZ
G	150	-	240 HERTZ
B	200	-	310 HERTZ
e	250	-	375 HERTZ



YOU CAN SAVE CUSTOM TUNINGS IN THE BLUE BANK ONLY. YOU CAN SELECT YOUR CUSTOM TUNING IN THE SAME MANNER AS ANY OTHER TUNING.



FUNCTION MENU **D** REFERENCE TUNING

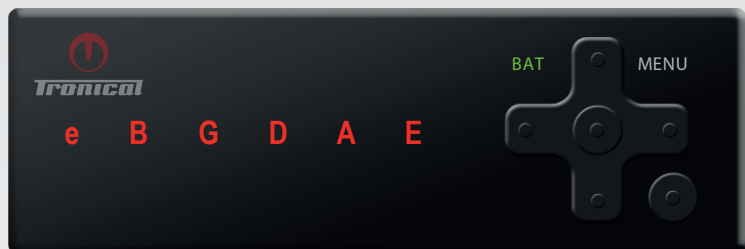

SEQUENCE

- 1) TUNE THE GUITAR TO THE DESIRED TUNING PRESET.
- 2) CHANGE THE PITCH OF ONE STRING (REFERENCE STRING) BY MANUALLY TURNING THE KEY.
- 3) ENTER AND EXECUTE REFERENCE MODE

TO ENTER REFERENCE TUNING MODE:

PUSH **"ON"** button. The system activates with the last completed tuning in **MULTI-STRING MODE**.

PUSH **"BACK"** button to enter **TUNING SELECTION MODE**. **MENU LED** is **OFF**.

PRESS AND HOLD THE **"UP"** button until **MENU LED** lights up **WHITE**.
PRESS **"LEFT/RIGHT"** button to **SELECT WHITE "D"-LED**.

PRESS **"ENTER"** for **REFERENCE TUNING MODE**. The **MENU LED** switches **OFF**
E-LED FLASHES RED.

PRESS **"LEFT/RIGHT"** button to **SELECT THE REFERENCE STRING**.

PLUCK YOUR REFERENCE STRING measurement begins indicated by quick **FLASHING YELLOW LED** of respective string. Upon completion, the respective led lights up **GREEN** and all others are shining **RED**.

STRUM ALL STRINGS (MULTI-STRING MODE).

The system will tune your guitar to the selected tuning preset in relation to the measured reference pitch.



THE LATEST COMPLETED REFERENCE TUNING IS AVAILABLE ON START-UP UNTIL YOU COMPLETE ANY OTHER TUNING.

SHOULD YOU WISH TO STORE YOUR REFERENCE TUNING REFER TO "CUSTOM TUNING" PAGE 23-24.

FUNCTION MENU **G** FIRMWARE VERSION



PUSH "ON" button. The system activates with the last completed tuning in MULTI-STRING MODE.

PUSH "BACK" button to enter TUNING SELECTION MODE. MENU LED IS OFF.

TO ENTER FUNCTION MENU:

PRESS AND HOLD "UP" until MENU LED lights up WHITE.

PRESS "LEFT/RIGHT" button to SELECT WHITE "G"-LED and PRESS "ENTER".

LED'S START FLASHING THREE TIMES, ONE TIME FOR EACH OF THE THREE FIRMWARE VERSION DIGITS. THE FIRST DIGIT NUMBER IS GREEN, THE SECOND BLUE AND THIRD RED. EACH COLOR SYMBOLIZES VALUES FROM 1-6 ACCORDING TO THE DIGITS.



ZERO IS SYMBOLIZED IF ALL LED'S ARE WHITE.

EXAMPLE: LED'S FLASH THREE TIMES

FLASH: 1



VERSION:

1

FLASH: 2

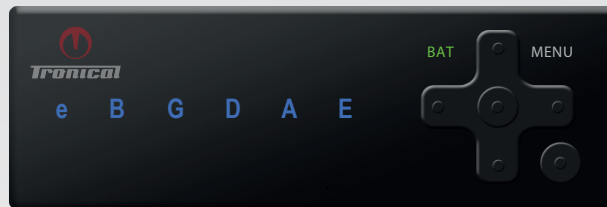

6

FLASH: 3



0

FUNCTION MENU **B** **BATTERY LEVEL**



PUSH **"ON"** button. The system activates with the last completed tuning in **MULTI-STRING MODE**.

PUSH **"BACK"** button to enter **TUNING SELECTION MODE**. **MENU LED** is **OFF**.

PRESS AND **HOLD** THE **"UP"** button until **MENU LED** lights up **WHITE**.

PRESS **"LEFT/RIGHT"** button to **SELECT WHITE LED-B** and PRESS **"ENTER"**.

A FULLY CHARGED BATTERY DISPLAYS ALL LED'S AS SHOWN LEFT.



IF THE BATTERY IS LOW (**YELLOW**), THE ROBOHEADS WILL LOSE PERFORMANCE. IF ONLY TWO RED LED'S (A & E) ARE DISPLAYED, CHARGE THE BATTERY IMMEDIATELY.

CONFIGURATION MENU >>> OVERVIEW

>>> ACCURACY LEVEL / ROBOHEAD DELAY /
RESET / ROBOHEAD SPEED / INTERFERENCE LEVEL

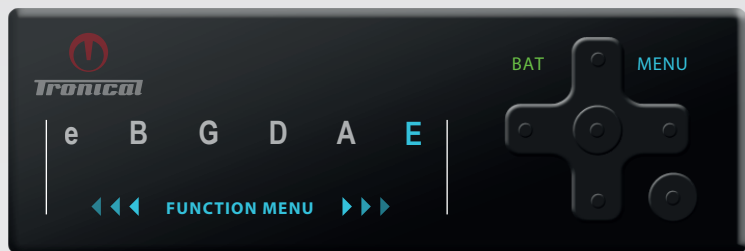
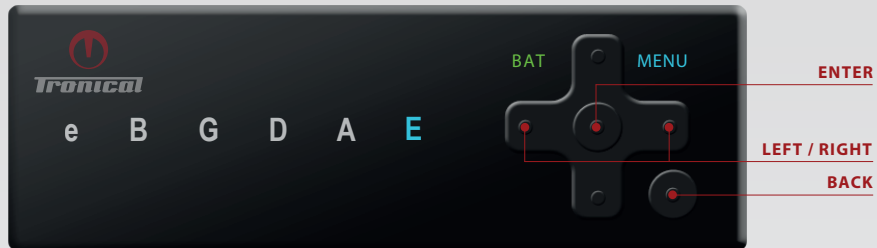

PUSH **"ON"** button. The system comes up with the last completed tuning in **MULTI-STRING MODE**.

PUSH **"BACK"** button to enter **TUNING SELECTION MODE**.
MENU LED is OFF.

TO ENTER **CONFIGURATION MENU**:

PRESS AND **HOLD** THE **"DOWN"** button until **MENU LED** and **"E"** TURNS **LIGHT BLUE**.

PRESS **"LEFT/RIGHT"** BUTTON TO SELECT THE DESIRED FUNCTION BELOW.

CONFIGURATION MENU OVERVIEW

- A** ACCURACY LEVEL (PG. 29)
- D** ROBOHEAD DELAY (PG. 30)
- G** RESET (PG. 31)
- B** ROBOHEAD SPEED (PG. 32)
- e** INTERFERENCE LEVEL (PG. 33)

CONFIGURATION MENU **A** ACCURACY MODE



EXAMPLE: HIGHEST ACCURACY LEVEL

PUSH **"ON"** button. The system comes up with the last completed tuning in **MULTI-STRING MODE**.

PUSH **"BACK"** button to enter **TUNING SELECTION MODE**. MENU LED IS OFF.

TO ENTER **CONFIGURATION MENU**:

PRESS AND **HOLD "DOWN"** button until MENU and **"E"** LED TURN **LIGHT BLUE**.

To access **ACCURACY MODE** SELECT **"A"-LED** and PRESS **"ENTER"**.

ACCURACY :

e	B	G	D	A	E	
+/-	+/-	+/-	+/-	+/-	+/-	
1.0	1.5	2.0	2.5	3.0	3.5	CENT

PRESS **"LEFT/RIGHT"** for desired accuracy level

PUSH **"ENTER"** to confirm



THE DEFAULT IS +/- 2.5 CENT (3 LED'S E-A-D).

THE HIGHEST ACCURACY LEVEL (ALL LED'S ON AS SHOWN LEFT) WILL **INCREASE TUNING TIME**.

A LOWER ACCURACY LEVEL WILL **DECREASE TUNING TIME** RESPECTIVELY.

CONFIGURATION MENU

D

ROBOHEAD DELAY



SET THE START-DELAY OF THE ROBOHEADS.

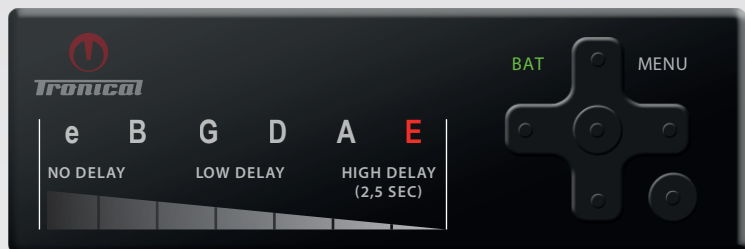

EXAMPLE: MAX DELAY



WHEN YOU CHANGE A TUNING THE ROBOHEADS WILL START IMMEDIATELY IN ORDER TO CHANGE THE PITCH. WITH THIS FUNCTION YOU CAN DELAY THE START UP TO 2.5 SECONDS.

PUSH **"ON"** button. The system comes up with the last completed tuning in MULTI-STRING MODE.

PUSH **"BACK"** button to enter **TUNING SELECTION MODE**. MENU LED is OFF.

TO ENTER **CONFIGURATION MENU**

PRESS AND HOLD **"DOWN"** button until MENU and **"LED-E"** LED TURN LIGHT BLUE.

TO ACCESS **ROBOHEAD DELAY** SELECT **"D"-LED** and PRESS **"ENTER"**.



THE DEFAULT IS NO DELAY (ALL LED'S ON).

PRESS **"LEFT/RIGHT"** to select desired delay level.

PRESS **"ENTER"** to confirm.

All String LED'S FLASH **GREEN** TWICE to confirm **SELECTED DELAY LEVEL** has been stored.

PUSH **"BACK"** for **CONFIGURATION MENU**.

THE MAX DELAY LEVEL AS SHOWN LEFT WILL DELAY THE START OF THE ROBOHEADS BY 2.5 SEC.

EACH ADDITIONAL LED DECREASES THE DELAY BY 0.5 SEC.

CONFIGURATION MENU RESET



PUSH **"ON"** button. The system comes up with the last completed tuning in **MULTI-STRING MODE**.

PUSH **"BACK"** button to enter **TUNING SELECTION MODE**. MENU LED is OFF.

TO ENTER **CONFIGURATION MENU**
PRESS AND **HOLD "DOWN"** button until MENU and **"E" LED** TURNS **LIGHT BLUE**.

TO ACCESS **RESET** SELECT **"G"-LED** and PRESS **"ENTER"**.

SELECT **"E"-LED** for reset of all **CUSTOM TUNINGS**.

SELECT **"A"-LED** for **FACTORY RESET** (all data).

To confirm **PRESS AND HOLD "UP"** and **PRESS AND HOLD "ENTER"** at the same time by **PUSHING IN BETWEEN BOTH BUTTONS**.

RESET STYLES OVERVIEW

-  RESET ALL CUSTOM TUNINGS
-  FACTORY RESET (RESET ALL DATA EXCEPT CUSTOMER TUNING DATA)

CONFIGURATION MENU **B** **ROBOHEAD SPEED**

SETS THE SPEED OF THE ROBOHEADS FOR ALL TUNING MODES.



EXAMPLE: HIGHEST SPEED LEVEL



USE THIS FUNCTION TO SET THE SPEED (AND ACCELERATION) OF THE ROBOHEADS. IF THE NECK OF YOUR GUITAR NEEDS MORE TIME TO STABILIZE WHEN CHANGING TUNINGS, REDUCE THE SPEED.

PUSH **"ON"** button. The system comes up with the last completed tuning in **MULTI-STRING MODE**.
PUSH **"BACK"** button to enter **TUNING SELECTION MODE**. MENU LED is OFF.

TO ENTER **CONFIGURATION MENU**
PRESS AND **HOLD "DOWN"** button until MENU and **"E" LED TURNS LIGHT BLUE**.

TO ACCESS **ROBOHEAD SPEED** SELECT **"B"-LED** and PRESS **"ENTER"**.



LESS ROBOHEAD SPEED CAN DECREASE STRESS TO THE STRINGS AND TO THE GUITAR NECK.

IN CASE OF FREQUENT STRING SNAPPING OR NO STABLE TUNING RESULTS AFTER LONG DISTANCE TUNINGS DUE TO NECK RELIEF, TRY A LOWER SPEED LEVEL.

SELECT ROBOHEAD SPEED BY PUSHING **"LEFT/RIGHT"**.
PRESS **"ENTER"** to confirm.



THE DEFAULT IS SET TO THE HIGHEST SPEED LEVEL AS SHOWN LEFT (ALL LED'S ON).

CONFIGURATION MENU INTERFERENCE LEVEL



EXAMPLE: HIGHEST INTERFERENCE LEVEL.



A GUITAR STRING IS PRODUCING NOT ONLY THE FUNDAMENTAL FREQUENCY BUT ALSO SEVERAL OVERTONES (E.G. THE E STRING IS PRODUCING 82.41 HERTZ AS FUNDAMENTAL AND OVERTONES AT 164.82, 247.23 AND SO FORTH).

THAT MEANS THAT THE E-STRING IS INTERFERING WITH THE B-STRING BECAUSE THE SECOND OVERTONE OF THE E-STRING AND THE FUNDAMENTAL OF THE B-STRING INTERFERE AROUND 247 HERTZ.

WHEN YOU RECOGNIZE THAT THE ROBOHEAD OF THE B STRING IS TURNING WITHOUT PLUCKING THE B-STRING REDUCE THE INTERFERENCE LEVEL. IF YOUR GUITAR IS NOT PRODUCING PRONOUNCED OVERTONES YOU CAN INCREASE THE INTERFERENCE LEVEL TO IMPROVE PERFORMANCE.

PUSH "ON" button. The system comes up with the last completed tuning in **MULTI-STRING MODE**.
PUSH "BACK" button to enter **TUNING SELECTION MODE**. MENU LED IS OFF.

To enter **CONFIGURATION MENU**
PRESS AND HOLD "DOWN" button until MENU and "E" LED TURNS **LIGHT BLUE**.
 TO ACCESS **INTERFERENCE LEVEL** SELECT "e"-LED and **PRESS "ENTER"**.



SETS THE GLOBAL INTERFERENCE LEVEL FOR ALL TUNING MODES.
 DEFAULT IS 3-LEDS

PUSH "LEFT/RIGHT" to select between a high and low interference level to prevent that the harmonic of a low string is recognized as a harmonic of a high string.

SYSTEM CONFIGURATION >>> OVERVIEW

>>> GAIN / GUITAR TYPE / PITCH WINDOW / DOUBLE CLICK

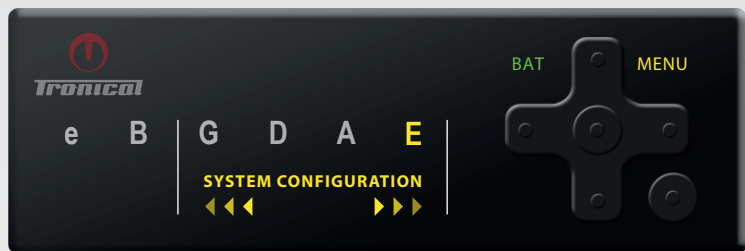

THE SYSTEM CONFIGURATION MENU IS USED TO CONFIGURE SYSTEM RELEVANT PARAMETERS LIKE GUITAR-TYPE, GAIN AND FREQUENCY SNAP. THE CLICKSTREAM TO ENTER THIS MENU IS MORE COMPLICATED TO PREVENT UNINTENDED CHANGES. THESE SETTINGS ARE AFFECTING SYSTEM PERFORMANCE AND ACCURACY. PLEASE STEP GENTLY.

PUSH **"ON"** button. The system comes up with the last completed tuning in MULTI-STRING MODE.

PUSH **"BACK"** button to enter TUNING SELECTION MODE. MENU LED IS OFF.

TO ENTER **SYSTEM CONFIGURATION**

PRESS AND **HOLD "RIGHT"** and PRESS AND **HOLD "ENTER"** at the same time by (**PRESSING IN BETWEEN BOTH BUTTONS**).

"MENU"-LED and **"E"**-LED LIGHT UP **YELLOW**.

PRESS **"LEFT/RIGHT"** to navigate through the menu (E, A, D).

PRESS **"ENTER"** to confirm or PRESS **"BACK"** for TUNING SELECTION MODE.

SYSTEM CONFIGURATION OVERVIEW

- E** → GAIN (PG. 32)
- A** → GUITAR TYPE (PG. 33)
- D** → PITCH WINDOW (PG.34)
- G** → SINGLE OR DOUBLE CLICK FOR TUNE (PG. 35)

SYSTEM CONFIGURATION **E** GAIN SETTINGS



TRONICAL TUNE HAS A SUPERIOR DYNAMIC RANGE TO SENSE THE SOLID-BORNE SOUND OF YOUR INSTRUMENT (>130DB). THIS IS ACHIEVED BY A PIEZO TRANSDUCER, A DYNAMICAL ADJUSTABLE AMPLIFIER AND A 24 ANALOG TO DIGITAL CONVERTER (ADC). WITH THE "GAIN SETTING" THE STARTING POINT OF THE AMPLIFIER IS SET. FROM THIS STARTING POINT THE AMPLIFIER IS ADJUSTED DURING THE TUNING PROCESS IN THE RANGE OF +-9DB.



WHEN YOU PERFORM A "CALIBRATION" A GOOD STARTING POINT FOR THE AMPLIFIER IS SET. YOU CAN OVERRIDE THE GAIN SETTING WITH THIS FUNCTION. BE CAREFUL WHEN CHANGING THE GAIN!

INCREASE THE GAIN IF STRINGS ARE NOT RECOGNIZED WHEN PLUCKED (STRING LED IS NOT GETTING YELLOW, STRING IS NOT TUNED) OR SIGNAL IS FADING OUT TOO QUICK.

DECREASE THE GAIN IF THE GUITAR IS TOO SENSITIVE OR IF USED IN LOUD ENVIRONMENTS WITH AMBIENT NOISE.

GAIN LEVEL : 2.5DB, 6DB, 9DB, 12DB, 15DB, 18DB

PUSH "ON" button. The system comes up with the last completed tuning in MULTI-STRING MODE.

PUSH "BACK" button to enter TUNING SELECTION MODE. MENU LED IS OFF.

TO ENTER **SYSTEM CONFIGURATION**

PRESS AND HOLD "RIGHT" and PRESS AND HOLD "ENTER" at the same time by (PRESSING IN BETWEEN BOTH BUTTONS).

"MENU"-LED AND "E"-LED LIGHT UP **YELLOW**.

SELECT THE PIEZO SIGNAL LEVEL BY PUSHING "LEFT/RIGHT".

PUSH "ENTER" to confirm.

PUSH "BACK" for **SYSTEM CONFIGURATION MENU**.





THE DEFAULT IS 3 LEDS AND WILL BE ADAPTED WHEN EXECUTING CALIBRATION MODE. SELECTING A DIFFERENT LEVEL WILL AFFECT SYSTEM PERFORMANCE OR CAN CAUSE MALFUNCTION.

SYSTEM CONFIGURATION **A** GUITAR TYPE



 GREEN "E" & BLUE "A" BLINKING LED'S:
ACOUSTIC GUITAR

 GREEN "E," BLUE "A," & RED "D" BLINKING LED'S:
TAYLOR GS MINI

 IT IS IMPORTANT TO SETUP THE SYSTEM TO THE RIGHT GUITAR TYPE. ACOUSTIC GUITARS ARE EQUIPPED WITH THICKER STRINGS AND SHOW DIFFERENT ACOUSTIC CHARACTERISTICS.

Push "**ON**" button. The system comes up with the last completed tuning in **MULTI-STRING MODE**.

Push "**BACK**" button to enter **TUNING SELECTION MODE**. "**MENU**" LED is **OFF**.

To enter **SYSTEM CONFIGURATION**:

PRESS and HOLD BOTH "**RIGHT**" and "**ENTER**" AT THE SAME TIME.

"**MENU**"-LED and "**E**"-LED LIGHT UP **YELLOW**.

For **GUITAR TYPE** select "**A**"-LED and press "**ENTER**".

The **DEFAULT SETTING** is **LED-E** for "ELECTRIC."

Use the "LEFT/RIGHT" button to change to the appropriate setting:

- | | |
|--|------------------|
| 1. GREEN "E" | (ELECTRIC) |
| 2. GREEN "E" & BLUE "A" | (ACOUSTIC) |
| 3. GREEN "E," BLUE "A," & RED "D" | (TAYLOR GS MINI) |

Press "**ENTER**" to **CONFIRM**.

SYSTEM CONFIGURATION **D** **PITCH WINDOW**



EXAMPLE:

Every time when a tuning is completed the system stores the actual pitch for each string. On re-tune the system checks if the actual string frequencies are within a certain PITCH WINDOW. If a string is outside its Pitch Window the corresponding LED turns purple. If at least one string is out of its Pitch Window the system turns automatically to **SINGLE TUNE MODE** after the remaining strings are tuned.

The Pitch Window can be adjusted from 25 to 150 Cent.

PITCH WINDOW

e	B	G	D	A	E	
25	35	50	75	100	150	CENT

PRESS "LEFT/RIGHT" for desired PITCH WINDOW.
PRESS "ENTER" to confirm.



DEFAULT IS 75 CENT = 4 LEDS.

EXAMPLE:

THE PITCH WINDOW IS SET TO 100CENT=5LEDS. THE LAST COMPLETED TUNING WAS A STANDARD EADGBE. NOW THE SYSTEM IS STARTED AGAIN. IF THE PITCH OF THE LOW E STRING IS MORE THAN 100CENT OFF, THE CORRESPONDING E-LED WOULD BECOME MAGENTA  (LOWER THAN EB OR HIGHER THAN F).

SYSTEM CONFIGURATION **G** SINGLE OR DOUBLE CLICK FOR TUNE



 GREEN BLINKING "E" LED :
SINGLE CLICK (DEFAULT)

 GREEN "E" & BLUE "A" BLINKING LED'S:
DOUBLE CLICK

 SELECT BETWEEN SINGLE CLICK OR DOUBLE CLICK TO ACTIVATE TUNING.

SINGLE CLICK: PRESS ONCE TO CONFIRM SELECTED TUNING

DOUBLE CLICK: PRESS TWICE TO CONFIRM SELECTED TUNING (MORE TIME TO REMOVE HAND OUT OF THE SYSTEM / ROBOHEADS)

Push the "ON" button. The system comes up with the last completed tuning in **MULTI-STRING MODE**.
Push the "BACK" button to enter **TUNING SELECTION MODE**. The "MENU" LED is off.

To enter **SYSTEM CONFIGURATION** **PRESS** and **HOLD** both "RIGHT" and "ENTER" **AT THE SAME TIME**.

The "MENU"-LED and "E"-LED light up **YELLOW**.

For **SINGLE OR DOUBLE CLICK TUNING**, SELECT "G"-LED and **PRESS "ENTER"**

Select either **LED-E** for "SINGLE CLICK" or **LED "A"** for "DOUBLE CLICK." **PRESS "ENTER"** to CONFIRM.

TRONICAL TUNE CHARGING THE BATTERY



BATTERY PACK

3.7V 340mAh 1258mWh LI-POLYMER

A BATTERY THAT HAS BEEN INFREQUENTLY USED, OR A NEW ONE, COULD HAVE REDUCED CAPACITY. YOU MAY NEED TO RECHARGE IT A NUMBER OF TIMES. WHEN THE BATTERY LEVEL IS LOW, THE BAT LED FLASHES RED.

CAUTION:

1. DO NOT CONNECT IMPROPERLY.
2. DO NOT DISPOSE OF IN FIRE OR EXPOSE TO EXCESS HEAT.
3. DO NOT CRUSH, PUNCTURE, INCINERATE OR SHORT CIRCUIT EXTERNAL CONTACTS.



CHARGING:

CHARGE THE BATTERY LATEST WHEN LED BAT IS SHINING RED.

LI-POLYMER CHARGER

INPUT: AC100-240V 50/60HZ

OUTPUT: 4.2V \pm 300mA



BATTERY IS CHARGING



BATTERY IS CHARGED



LEGAL INFORMATION

Guidelines for safe and efficient use.

! Read this information before using Tronical Tune.

PRODUCT CARE:

Do not expose your product to liquid or moisture or to humidity.

Do not expose your product to extreme high or low temperatures.

Do not expose your product to lit candles, cigarettes, or cigars, or to open flames etc.

Do not drop, throw or try to bend the product as rough treatment could damage it.

Do not attempt to disassemble your product. The product does not contain consumer serviceable or replaceable components. Only Tronical GmbH should perform service.

If you will not be using the product for a while, store it in a place that is dry, free from damp, dust and extreme temperatures.

DISPOSAL OF OLD ELECTRICAL & ELECTRONIC EQUIPMENT:

 This symbol on the product indicates that this product shall not be treated as household waste. Instead it shall be handed over to the applicable collection point for the recycling of electrical and electronic equipment. By ensuring this product is disposed of correctly, you will help prevent potential negative consequences for the environment and human health, which could otherwise be caused by inappropriate waste handling of this product. The recycling of materials will help to conserve natural resources. For more detailed information about recycling of this product, please contact your local city office, your household waste disposal service or the shop where you purchased the product.

POWER SUPPLY

Connect the AC power adapter only to designated power sources as marked on the product. To reduce risk of damage to electric cord, remove it from the outlet by holding onto the AC adapter rather than the cord. Make sure the cord is positioned so that it will not be stepped on, tripped over or otherwise subjected to damage or stress. To reduce risk of electric shock, unplug the unit from any power source before attempting to clean it. »

The AC power adapter must not be used outdoors or in damp areas. DANGER - Never alter the AC cord or plug. If the plug will not fit into the outlet, have a proper outlet installed by a qualified electrician. Improper connection can result in risk of electric shock.

CHILDREN:

Do not allow children to play with Tronical Tune since it contains small parts that could become detached and create a choking hazard.

BATTERY INFORMATION:

A rechargeable battery has long service life if treated properly. A new battery or one that has not been used for a long period of time could have reduced capacity the first few times it is used. Do not expose the battery to extreme temperatures, never above +55° C (+131° F). For maximum battery capacity, use the battery in room temperature. If the battery is used in low temperatures, the battery capacity will be reduced. The battery can only be charged in temperatures between +10°C (+50° F) and +45° C (+113° F).

RECYCLING THE BATTERY:

The battery in your Tronical Tune must be disposed of properly and should never be placed in municipal waste.

! CAUTION:

1. DO NOT CONNECT IMPROPERLY.
2. DO NOT DISPOSE OF IN FIRE OR EXPOSE TO EXCESS HEAT.
3. DO NOT CRUSH, PUNCTURE, INCINERATE OR SHORT CIRCUIT EXTERNAL CONTACTS.





Tronical
COMPONENTS

Tronical Components GmbH • Heselstücken 18 •
D-22453 Hamburg Germany
Web: www.tronical.com • Mail: info@tronical-components.com
HRB 94503

© Copyright 2012 Tronical-Components GmbH. All rights reserved.